

4MP Fixed Lens IR PT Camera

IPC744SR5-PF40 (60)-32G



Key Features

PTZ

- Precision motor with accuracy deviation less than 0.1 degree.
- Pan range 250°, tilt range -50° to 50°
- Pan speed up to 15°/s, tilt speed up to 5°/s

Optics

- Smart IR, up to 50m (164 ft) IR distance
- IR anti-reflection window to increase the infrared transmittance
- Day/night functionality

Compression

- Ultra 265, H.265, H.264, MJPEG
- Embedded smart algorithm
- Triple streams
- Customized OSD

Network

- ONVIF Conformance

Structure

- Support PoE power supply
- Wide temperature range: -35°C to +60°C (-31°F to +140°F)
- Wide voltage range of ±25%
- IP66

Specifications

	IPC744SR5-PF40-32G	IPC744SR5-PF60-32G
Camera		
Sensor	1/3", progressive scan ,4.0 megapixel, CMOS	
Lens	4.0mm@F1.8	6.0mm@F1.8
Angle of view(H)	78.9°	49.9°
Shutter	Auto/Manual, 1/6s ~ 1/100000s	
Minimum Illumination	Color: 0.03 Lux× (F1.8, AGC ON) 0 Lux with IR on	
Day/Night	IR-cut filter with auto switch (ICR)	
Digital noise reduction	2D/3D DNR	
S/N	>55dB	
IR Range	50m (164 ft) IR range	
Defog	Digital Defog	
WDR	120dB	
Video		
Video Compression	Ultra 265,H.265, H.264, MJPEG	
H.264 code profile	Baseline profile, Main Profile, High Profile	
Frame Rate	Main Stream:4MP (2592×1520): Max. 20 fps, 4MP (2560×1440): Max. 25 fps, 3MP (2048×1520): Max. 30 fps; Sub Stream:2MP (1920×1080): Max. 30 fps; Third Stream:D1(720×576) : Max. 30fps	
HLC	Supported	
BLC	Supported	
OSD	Up to 8 OSDs	
Privacy Mask	Up to 8 areas	
ROI	Up to 8 areas	
Motion Detection	Up to 4 areas	
Smart		
Behavior Detection	Intrusion, cross line, motion detection	
Exception Detection	Audio detection	
Intelligent Identification	Face detection	
Statistical Analysis	People counting	
General Function	Watermark, IP Address Filtering, Tampering Alarm, Alarm input, Alarm output, Access Policy, ARP Protection, RTSP Authentication, User Authentication	
Audio		
Audio Compression	G.711	
Two-way Audio	Supported	
Suppression	Supported	
Sampling Rate	8 KHZ	
Storage		
Edge Storage	Built-in 32 GB eMMC	
Network Storage	ANR	

Network	
Protocol	IPv4, IGMP, ICMP, ARP, TCP, UDP, DHCP, PPPoE, RTP, RTSP, RTCP, DNS, DDNS, NTP, FTP, UPnP, HTTP, HTTPS, SMTP, 802.1x, SNMP
Compatibility	ONVIF(Profile S), API
Structure	
Pan Range	250°
Pan Speed	0.1°/s ~ 15°/s
	Preset speed: 15°/s
Tilt Range	-50° ~ 50°
Tilt Speed	0.1°/s ~ 5°/s
	Preset speed: 5°/s
Number of Presets	400
Patrol	Up to 16 patrols, up to 32 presets per patrol
Interface	
Audio I/O	3.5 mm connector
	Input: impedance 35 kΩ; amplitude 2 V [p-p]
	Output: impedance 600 Ω; amplitude 2 V [p-p]
Alarm I/O	2 / 1
Network	10M/100M adaptive Ethernet
General	
Power	12 V DC±25%, PoE (IEEE802.3at)
	Power consumption: Max. 17.23 W
Dimensions	357 mm × 106 mm × 194 mm (14.1" × 4.2" × 7.7")
Weight	1.16 kg (2.6 lb)
Working Environment	-35°C to +60°C (-31°F to 140°F), Humidity:10%~95% RH(non-condensing)
Ingress Protection	IP66

Dimensions

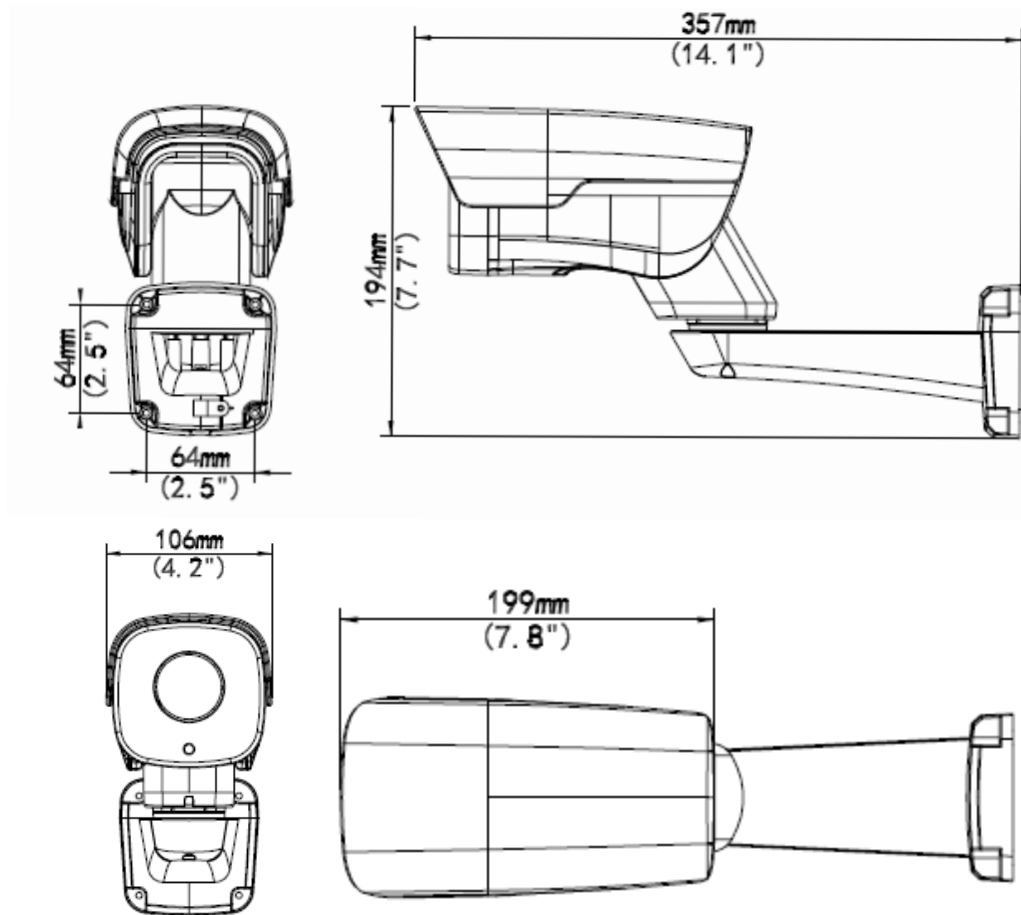

Accessories

Installation mode	Accessories	Description
Wall mount	\	Mounting pedestal is included in the Product package
Ceiling mount	\	Mounting pedestal is included in the Product package

Zhejiang Uniview Technologies Co., Ltd.

South Tower, Building 10, Wanlun Science Park, 88 Jiangling Road, Hangzhou, P.R.China 310051

Email: overseasbusiness@uniview.com; globalsupport@uniview.com

<http://www.uniview.com>

©2016-2017 Zhejiang Uniview Technologies Co., Ltd. All rights reserved.

*Product specifications and availability are subject to change without notice.